

BFP840FESD

SiGe:C NPN RF bipolar transistor



Product description

The BFP840FESD is a discrete RF heterojunction bipolar transistor (HBT) with an integrated ESD protection suitable for 5 GHz band applications.



Feature list

- Unique combination of high end RF performance and robustness: 20 dBm maximum RF input power, 1.5 kV HBM ESD hardness
- High transition frequency $f_T = 85$ GHz to enable best in class noise performance at high frequencies: $NF_{min} = 0.75$ dB at 5.5 GHz, 1.8 V, 5 mA
- High gain $G_{ms} = 23$ dB at 5.5 GHz, 1.8 V, 10 mA
- $OIP_3 = 22$ dBm at 5.5 GHz, 1.8 V, 10 mA
- Suitable for low voltage applications e.g. $V_{CC} = 1.2$ V and 1.8 V (2.85 V, 3.3 V, 3.6 V require a corresponding collector resistor)

Product validation

Qualified for industrial applications according to the relevant tests of JEDEC47/20/22.

Potential applications

- WLAN, WiMAX and UWB
- Satellite communication systems: satellite radio (SDARs, DAB), navigation systems (e.g. GPS, GLONASS, BeiDou, Galileo)

Device information

Table 1 Part information

Product name / Ordering code	Package	Pin configuration				Marking	Pieces / Reel
BFP840FESD / BFP840FESDH6327XTSA1	TSFP-4-1	1 = B	2 = E	3 = C	4 = E	T8s	3000

Attention: ESD (Electrostatic discharge) sensitive device, observe handling precautions

Table of contents

	Product description	1
	Feature list	1
	Product validation	1
	Potential applications	1
	Device information	1
	Table of contents	2
1	Absolute maximum ratings	3
2	Thermal characteristics	4
3	Electrical characteristics	5
3.1	DC characteristics	5
3.2	General AC characteristics	5
3.3	Frequency dependent AC characteristics	6
3.4	Characteristic DC diagrams	10
3.5	Characteristic AC diagrams	13
4	Package information TSFP-4-1	20
	Revision history	21
	Disclaimer	22

Absolute maximum ratings

1 Absolute maximum ratings

Table 2 Absolute maximum ratings at $T_A = 25\text{ °C}$ (unless otherwise specified)

Parameter	Symbol	Values		Unit	Note or test condition
		Min.	Max.		
Collector emitter voltage	V_{CEO}	-	2.25	V	Open base
			2.0		$T_A = -55\text{ °C}$, open base
Collector base voltage ¹⁾	V_{CBO}	-	2.9	V	Open emitter
			2.6		$T_A = -55\text{ °C}$, open emitter
Collector emitter voltage ²⁾	V_{CES}	-	2.25	V	E-B short circuited
			2.0		$T_A = -55\text{ °C}$, E-B short circuited
Base current	I_B	-5	3	mA	-
Collector current	I_C	-	35	mA	-
RF input power	P_{RFin}	-	20	dBm	-
ESD stress pulse	V_{ESD}	-1.5	1.5	kV	HBM, all pins, acc. to JESD22-A114
Total power dissipation ³⁾	P_{tot}	-	75	mW	$T_S \leq 109\text{ °C}$
Junction temperature	T_J	-	150	°C	-
Storage temperature	T_{Stg}	-55			

Attention: *Stresses above the max. values listed here may cause permanent damage to the device. Exposure to absolute maximum rating conditions for extended periods may affect device reliability. Exceeding only one of these values may cause irreversible damage to the integrated circuit.*

¹ V_{CBO} is similar to V_{CEO} due to design.

² V_{CES} is similar to V_{CEO} due to design.

³ T_S is the soldering point temperature. T_S is measured on the emitter lead at the soldering point of the PCB.

Thermal characteristics

2 Thermal characteristics

Table 3 Thermal resistance

Parameter	Symbol	Values			Unit	Note or test condition
		Min.	Typ.	Max.		
Junction - soldering point	R_{thJS}	-	541	-	K/W	-

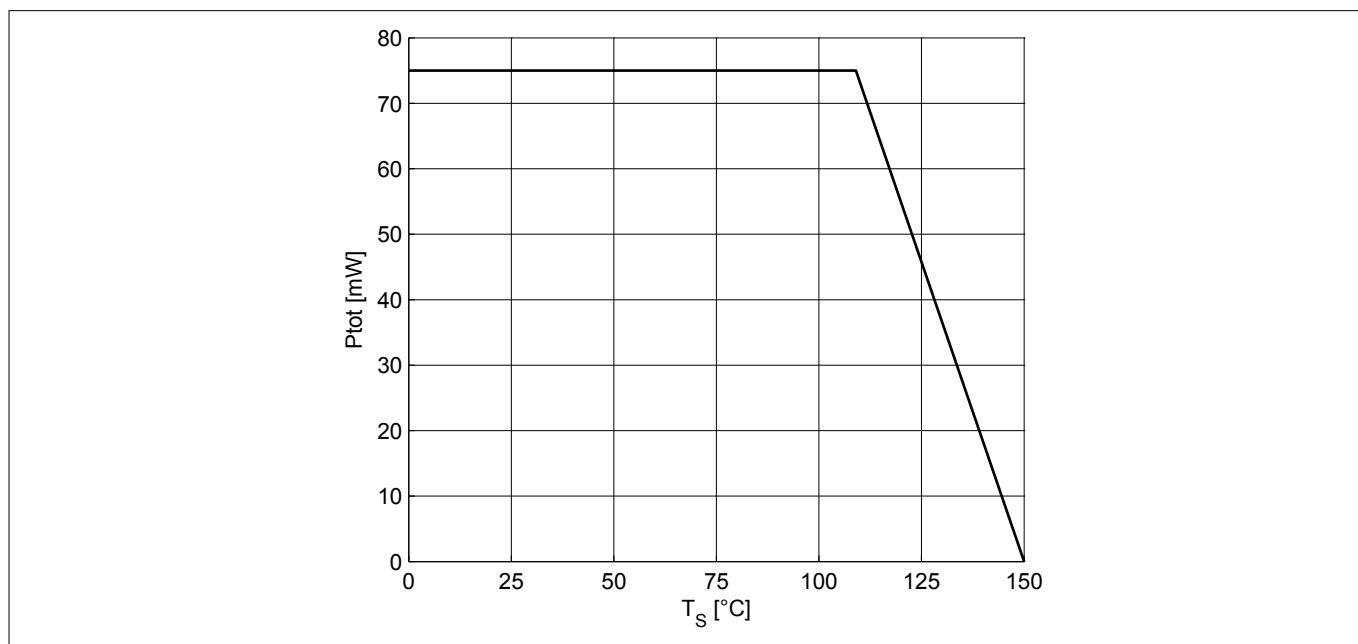

Figure 1 Total power dissipation $P_{tot} = f(T_s)$

Electrical characteristics

3 Electrical characteristics

3.1 DC characteristics

Table 4 DC characteristics at $T_A = 25\text{ °C}$

Parameter	Symbol	Values			Unit	Note or test condition
		Min.	Typ.	Max.		
Collector emitter breakdown voltage	$V_{(BR)CEO}$	2.25	2.6	–	V	$I_C = 1\text{ mA}$, $I_B = 0$, open base
Collector emitter leakage current	I_{CES}	–	–	400 ¹⁾	nA	$V_{CE} = 1.5\text{ V}$, $V_{BE} = 0$, E-B short circuited
Collector base leakage current	I_{CBO}			400 ¹⁾		$V_{CB} = 1.5\text{ V}$, $I_E = 0$, open emitter
Emitter base leakage current	I_{EBO}			10 ¹⁾	μA	$V_{EB} = 0.5\text{ V}$, $I_C = 0$, open collector
DC current gain	h_{FE}	150	260	450		$V_{CE} = 1.8\text{ V}$, $I_C = 10\text{ mA}$, pulse measured

3.2 General AC characteristics

Table 5 General AC characteristics at $T_A = 25\text{ °C}$

Parameter	Symbol	Values			Unit	Note or test condition
		Min.	Typ.	Max.		
Transition frequency	f_T	–	85	–	GHz	$V_{CE} = 1.8\text{ V}$, $I_C = 25\text{ mA}$, $f = 2\text{ GHz}$
Collector base capacitance	C_{CB}		38		fF	$V_{CB} = 1.8\text{ V}$, $V_{BE} = 0$, $f = 1\text{ MHz}$, emitter grounded
Collector emitter capacitance	C_{CE}		0.37		pF	$V_{CE} = 1.8\text{ V}$, $V_{BE} = 0$, $f = 1\text{ MHz}$, base grounded
Emitter base capacitance	C_{EB}		0.37			$V_{EB} = 0.4\text{ V}$, $V_{CB} = 0$, $f = 1\text{ MHz}$, collector grounded

¹ Maximum values not limited by the device but by the short cycle time of the 100% test

Electrical characteristics

3.3 Frequency dependent AC characteristics

Measurement setup is a test fixture with Bias-T's in a 50 Ω system, $T_A = 25\text{ °C}$.

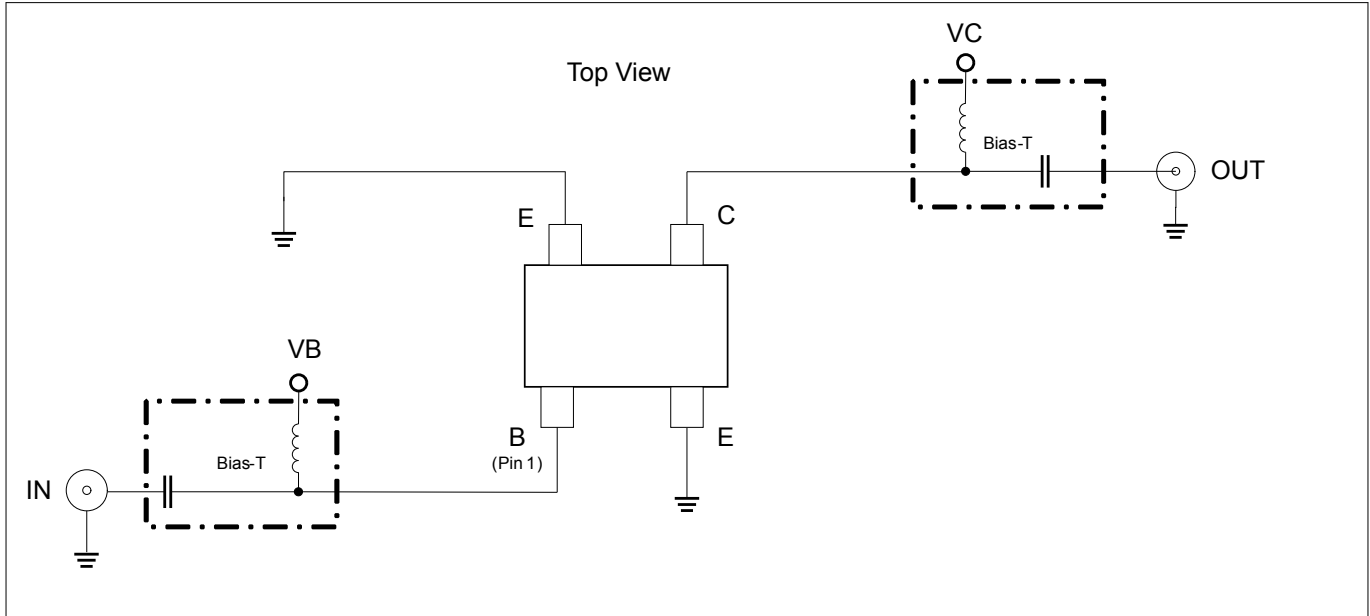

Figure 2 Testing circuit

Table 6 AC characteristics, $V_{CE} = 1.8\text{ V}$, $f = 0.45\text{ GHz}$

Parameter	Symbol	Values			Unit	Note or test condition
		Min.	Typ.	Max.		
Power gain		-		-	dB	$I_C = 10\text{ mA}$
<ul style="list-style-type: none"> Maximum power gain Transducer gain 	G_{ms} $ S_{21} ^2$		35 28			
Noise figure					dB	$I_C = 5\text{ mA}$
<ul style="list-style-type: none"> Minimum noise figure Associated gain 	NF_{min} G_{ass}		0.55 27			
Linearity					dBm	$Z_S = Z_L = 50\text{ }\Omega$, $I_C = 10\text{ mA}$
<ul style="list-style-type: none"> 3rd order intercept point at output 1 dB gain compression point at output 	OIP_3 OP_{1dB}		19.5 4			

Electrical characteristics

Table 7 AC characteristics, $V_{CE} = 1.8\text{ V}$, $f = 0.9\text{ GHz}$

Parameter	Symbol	Values			Unit	Note or test condition
		Min.	Typ.	Max.		
Power gain		-		-	dB	$I_C = 10\text{ mA}$
<ul style="list-style-type: none"> Maximum power gain Transducer gain 	G_{ms} $ S_{21} ^2$		 31 27			
Noise figure						dB
<ul style="list-style-type: none"> Minimum noise figure Associated gain 	NF_{min} G_{ass}	 0.6 26.5				
Linearity				dBm	$Z_S = Z_L = 50\ \Omega$, $I_C = 10\text{ mA}$	
<ul style="list-style-type: none"> 3rd order intercept point at output 1 dB gain compression point at output 	OIP_3 OP_{1dB}	 19.5 4				

Table 8 AC characteristics, $V_{CE} = 1.8\text{ V}$, $f = 1.5\text{ GHz}$

Parameter	Symbol	Values			Unit	Note or test condition
		Min.	Typ.	Max.		
Power gain		-		-	dB	$I_C = 10\text{ mA}$
<ul style="list-style-type: none"> Maximum power gain Transducer gain 	G_{ms} $ S_{21} ^2$		 28.5 26			
Noise figure						dB
<ul style="list-style-type: none"> Minimum noise figure Associated gain 	NF_{min} G_{ass}	 0.6 25				
Linearity				dBm	$Z_S = Z_L = 50\ \Omega$, $I_C = 10\text{ mA}$	
<ul style="list-style-type: none"> 3rd order intercept point at output 1 dB gain compression point at output 	OIP_3 OP_{1dB}	 20 4				

Table 9 AC characteristics, $V_{CE} = 1.8\text{ V}$, $f = 1.9\text{ GHz}$

Parameter	Symbol	Values			Unit	Note or test condition
		Min.	Typ.	Max.		
Power gain		-		-	dB	$I_C = 10\text{ mA}$
<ul style="list-style-type: none"> Maximum power gain Transducer gain 	G_{ms} $ S_{21} ^2$		 27.5 25.5			
Noise figure						dB
<ul style="list-style-type: none"> Minimum noise figure Associated gain 	NF_{min} G_{ass}	 0.65 24				
Linearity				dBm	$Z_S = Z_L = 50\ \Omega$, $I_C = 10\text{ mA}$	
<ul style="list-style-type: none"> 3rd order intercept point at output 1 dB gain compression point at output 	OIP_3 OP_{1dB}	 21 4.5				

Electrical characteristics

Table 10 AC characteristics, $V_{CE} = 1.8\text{ V}$, $f = 2.4\text{ GHz}$

Parameter	Symbol	Values			Unit	Note or test condition
		Min.	Typ.	Max.		
Power gain	G_{ms} $ S_{21} ^2$	-	26.5	-	dB	$I_C = 10\text{ mA}$
• Maximum power gain			24			
• Transducer gain						
Noise figure	NF_{min} G_{ass}		0.65		dB	$I_C = 5\text{ mA}$
• Minimum noise figure			22.5			
• Associated gain						
Linearity	OIP_3 OP_{1dB}		21		dBm	$Z_S = Z_L = 50\ \Omega$, $I_C = 10\text{ mA}$
• 3rd order intercept point at output			4			
• 1 dB gain compression point at output						

Table 11 AC characteristics, $V_{CE} = 1.8\text{ V}$, $f = 3.5\text{ GHz}$

Parameter	Symbol	Values			Unit	Note or test condition
		Min.	Typ.	Max.		
Power gain	G_{ms} $ S_{21} ^2$	-	25	-	dB	$I_C = 10\text{ mA}$
• Maximum power gain			22			
• Transducer gain						
Noise figure	NF_{min} G_{ass}		0.7		dB	$I_C = 5\text{ mA}$
• Minimum noise figure			20.5			
• Associated gain						
Linearity	OIP_3 OP_{1dB}		22.5		dBm	$Z_S = Z_L = 50\ \Omega$, $I_C = 10\text{ mA}$
• 3rd order intercept point at output			5			
• 1 dB gain compression point at output						

Table 12 AC characteristics, $V_{CE} = 1.8\text{ V}$, $f = 5.5\text{ GHz}$

Parameter	Symbol	Values			Unit	Note or test condition
		Min.	Typ.	Max.		
Power gain	G_{ms} $ S_{21} ^2$	-	23	-	dB	$I_C = 10\text{ mA}$
• Maximum power gain			19			
• Transducer gain						
Noise figure	NF_{min} G_{ass}		0.75		dB	$I_C = 5\text{ mA}$
• Minimum noise figure			17.5			
• Associated gain						
Linearity	OIP_3 OP_{1dB}		22		dBm	$Z_S = Z_L = 50\ \Omega$, $I_C = 10\text{ mA}$
• 3rd order intercept point at output			5			
• 1 dB gain compression point at output						

Electrical characteristics

Table 13 AC characteristics, $V_{CE} = 1.8 \text{ V}$, $f = 10 \text{ GHz}$

Parameter	Symbol	Values			Unit	Note or test condition
		Min.	Typ.	Max.		
Power gain		-		-	dB	$I_C = 10 \text{ mA}$
<ul style="list-style-type: none"> Maximum power gain Transducer gain 	G_{ma} $ S_{21} ^2$		 16 13			
Noise figure					dB	$I_C = 5 \text{ mA}$
<ul style="list-style-type: none"> Minimum noise figure Associated gain 	NF_{min} G_{ass}		 1.1 13			
Linearity					dBm	$Z_S = Z_L = 50 \Omega$, $I_C = 10 \text{ mA}$
<ul style="list-style-type: none"> 3rd order intercept point at output 1 dB gain compression point at output 	OIP_3 OP_{1dB}		 19.5 3			

Table 14 AC characteristics, $V_{CE} = 1.8 \text{ V}$, $f = 12 \text{ GHz}$

Parameter	Symbol	Values			Unit	Note or test condition
		Min.	Typ.	Max.		
Power gain		-		-	dB	$I_C = 10 \text{ mA}$
<ul style="list-style-type: none"> Maximum power gain Transducer gain 	G_{ma} $ S_{21} ^2$		 15.5 10.5			
Noise figure					dB	$I_C = 5 \text{ mA}$
<ul style="list-style-type: none"> Minimum noise figure Associated gain 	NF_{min} G_{ass}		 1.3 10.5			
Linearity					dBm	$Z_S = Z_L = 50 \Omega$, $I_C = 10 \text{ mA}$
<ul style="list-style-type: none"> 3rd order intercept point at output 1 dB gain compression point at output 	OIP_3 OP_{1dB}		 18.5 1.5			

Note: $G_{ms} = |S_{21} / S_{12}|$ for $k < 1$; $G_{ma} = |S_{21} / S_{12}| (k - (k^2 - 1)^{1/2})$ for $k > 1$. In order to get the NF_{min} values stated in this chapter, the test fixture losses have been subtracted from all measured results. OIP_3 value depends on termination of all intermodulation frequency components. Termination used for this measurement is 50Ω from 0.2 MHz to 12 GHz.

Electrical characteristics

3.4 Characteristic DC diagrams

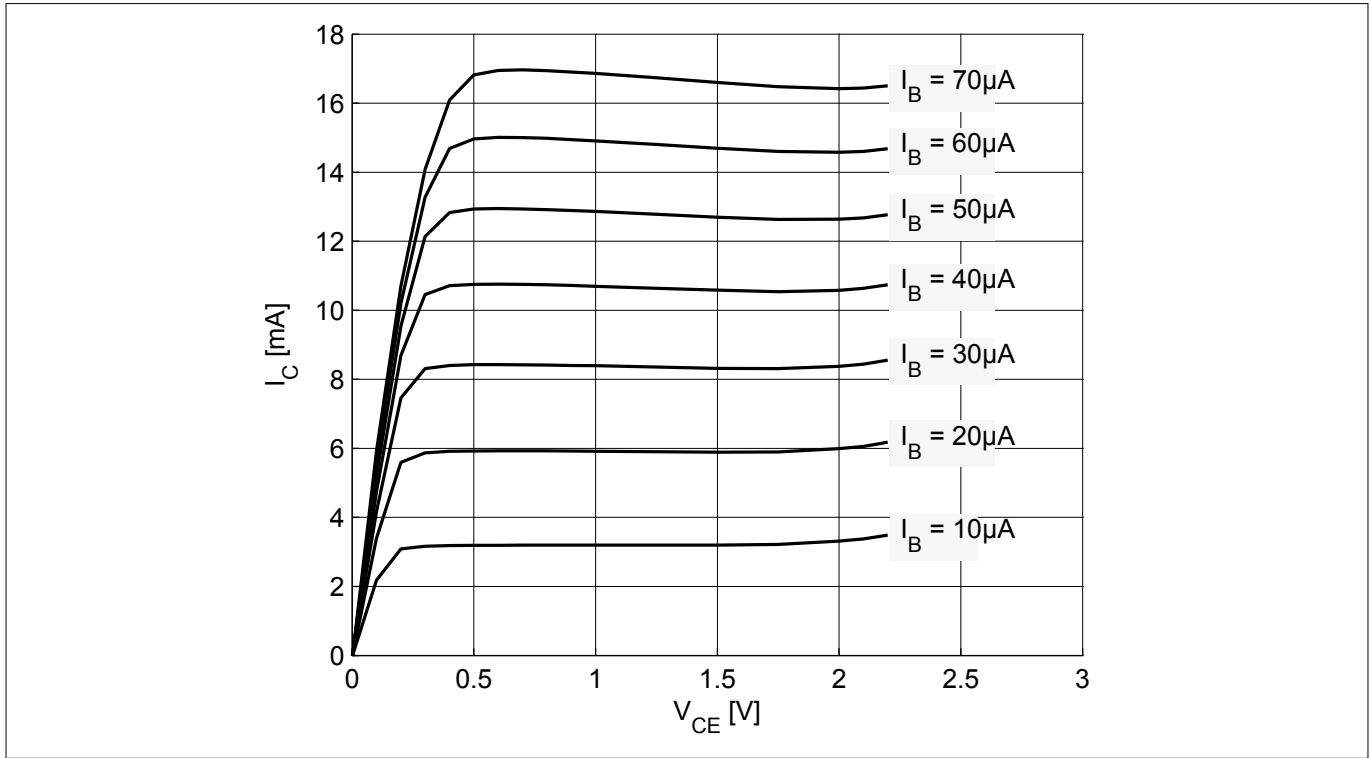

Figure 3 Collector current vs. collector emitter voltage $I_C = f(V_{CE}), I_B = \text{parameter}$

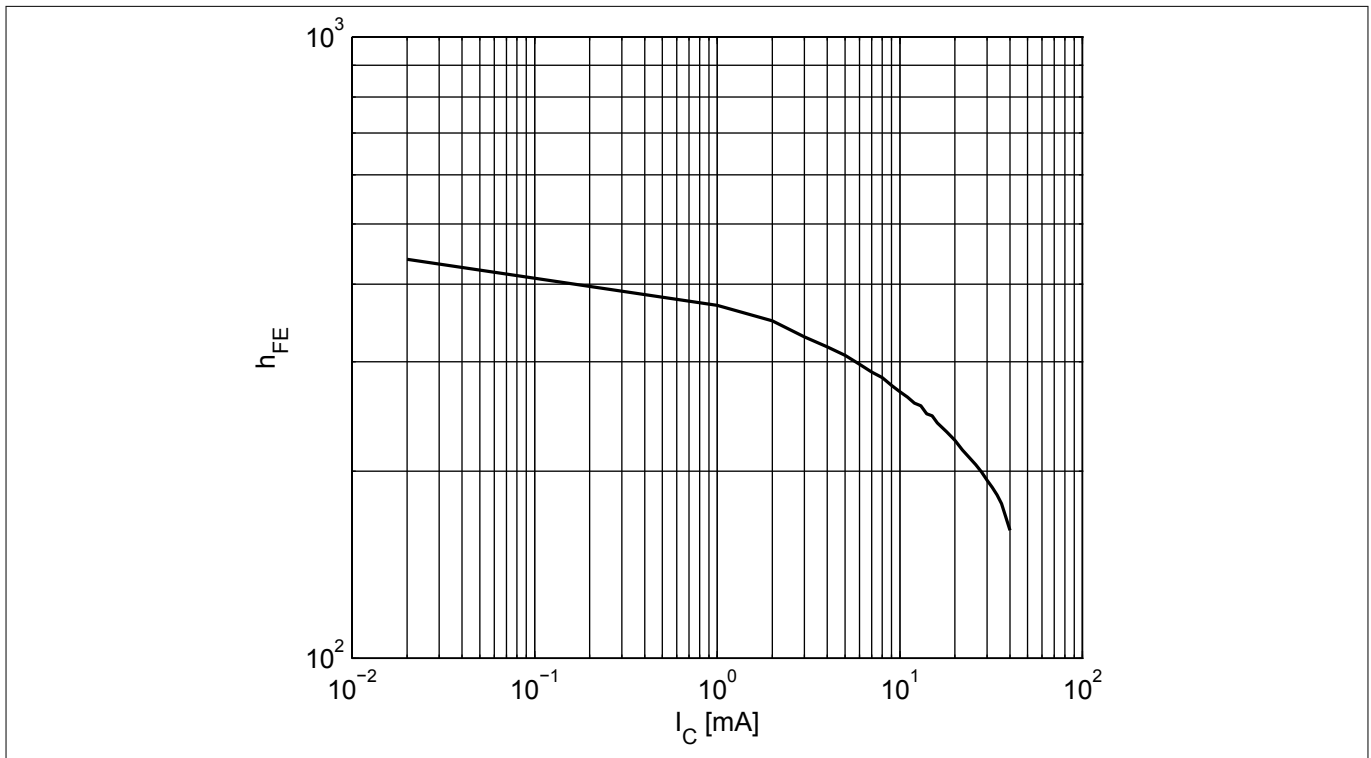

Figure 4 DC current gain $h_{FE} = f(I_C), V_{CE} = 1.8 \text{ V}$

Electrical characteristics

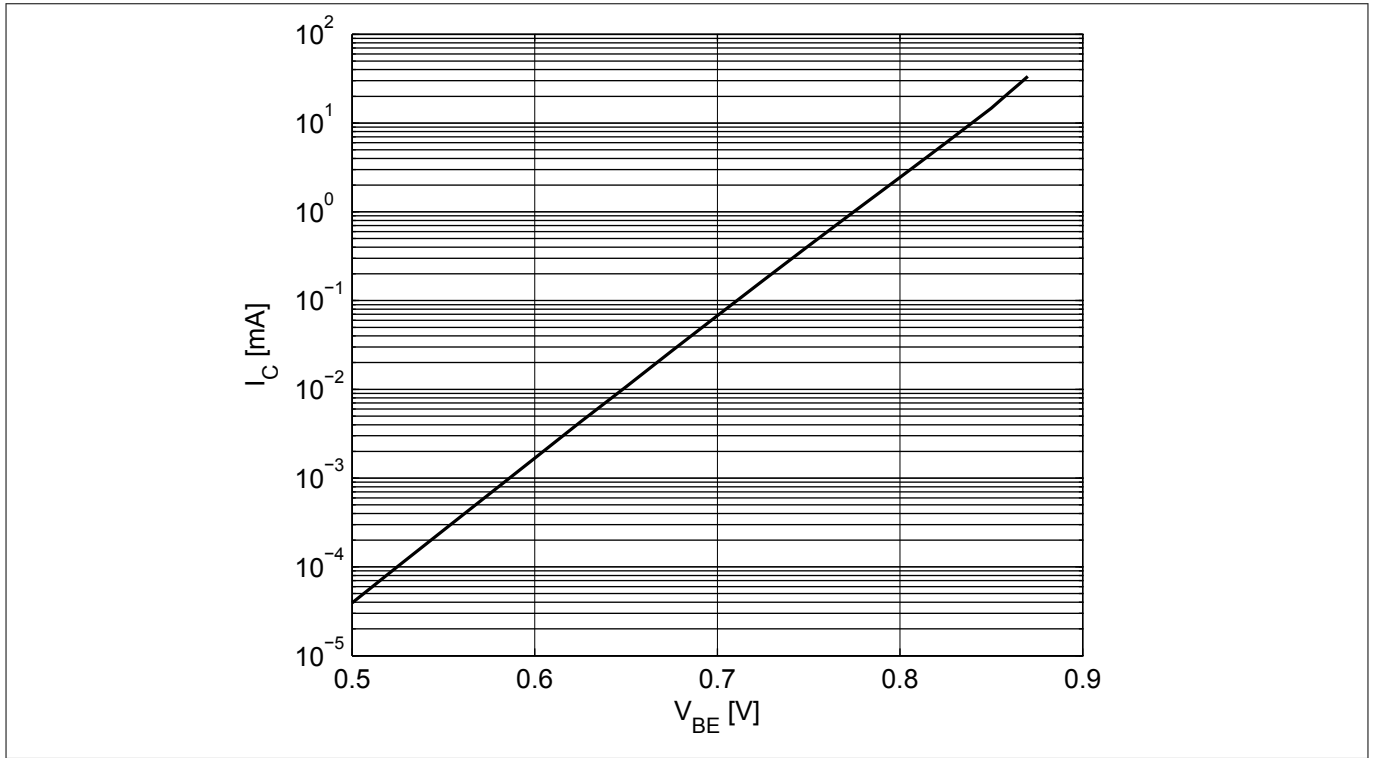

Figure 5 Collector current vs. base emitter forward voltage $I_C = f(V_{BE})$, $V_{CE} = 1.8$ V

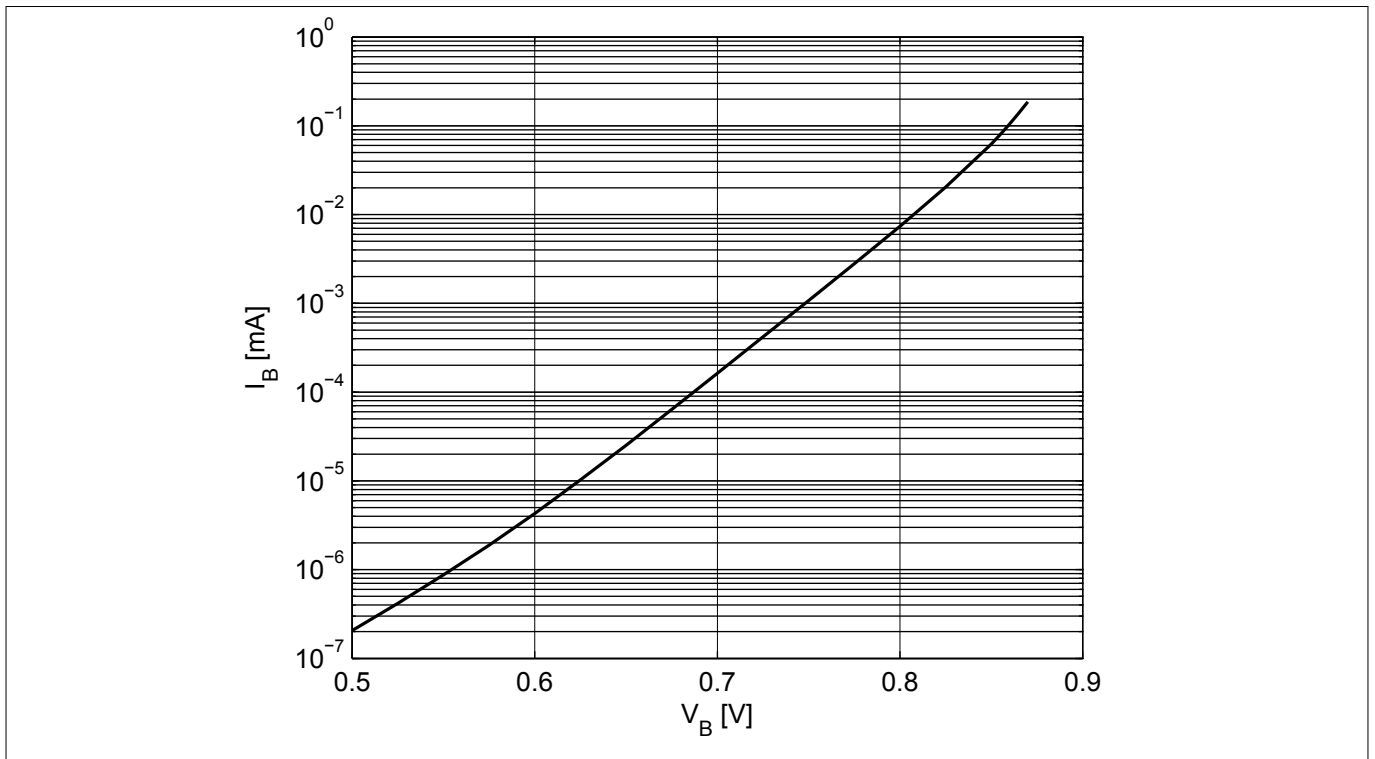

Figure 6 Base current vs. base emitter forward voltage $I_B = f(V_{BE})$, $V_{CE} = 1.8$ V

Electrical characteristics

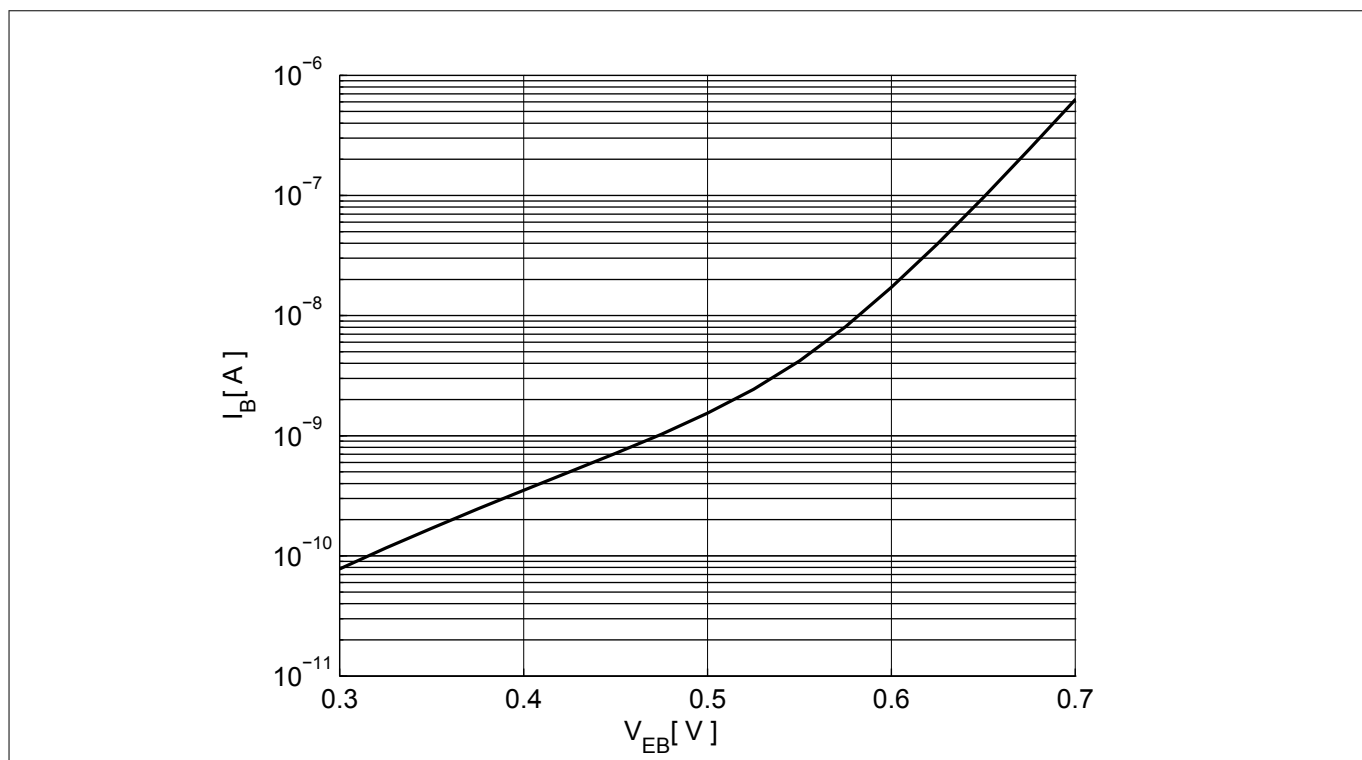

Figure 7 Base current vs. base emitter reverse voltage $I_B = f(V_{EB})$, $V_{CE} = 1.8$ V

Electrical characteristics

3.5 Characteristic AC diagrams

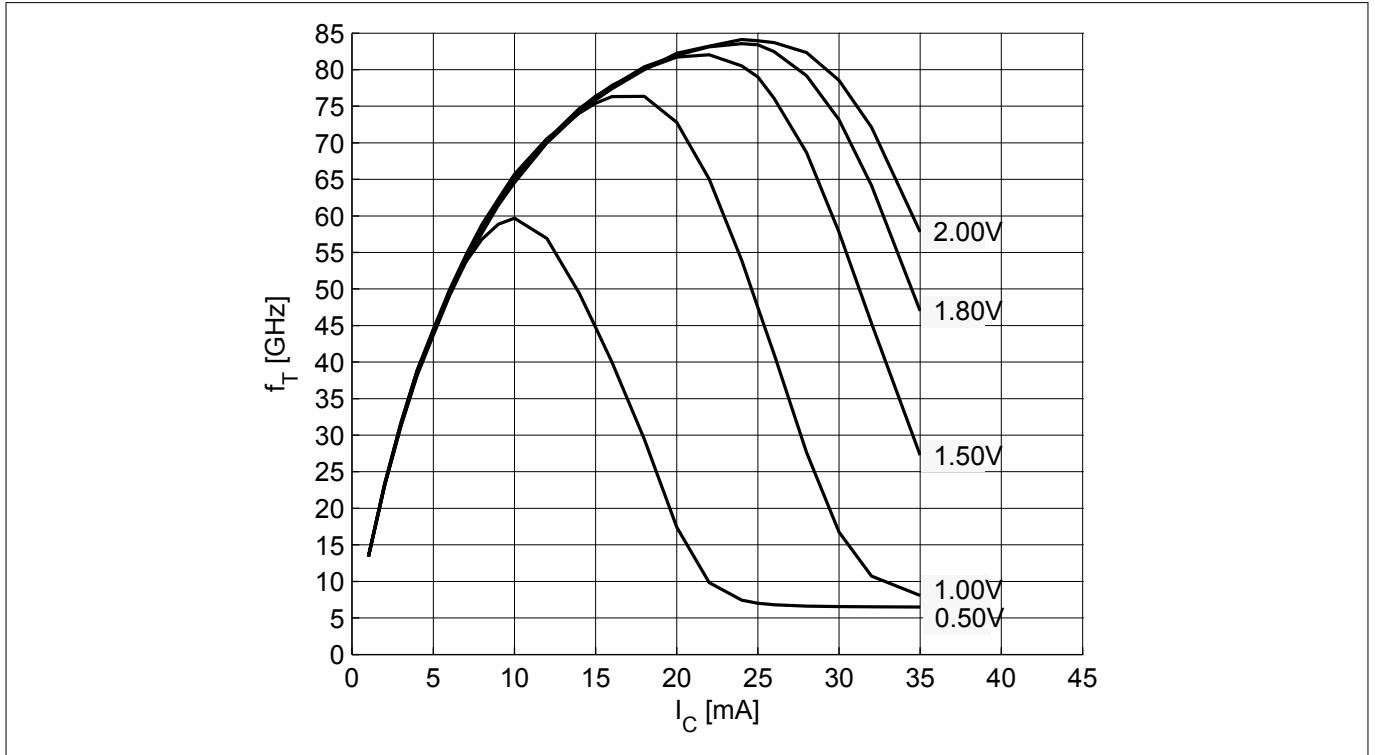

Figure 8 Transition frequency $f_T = f(I_C)$, $f = 2$ GHz, $V_{CE} =$ parameter

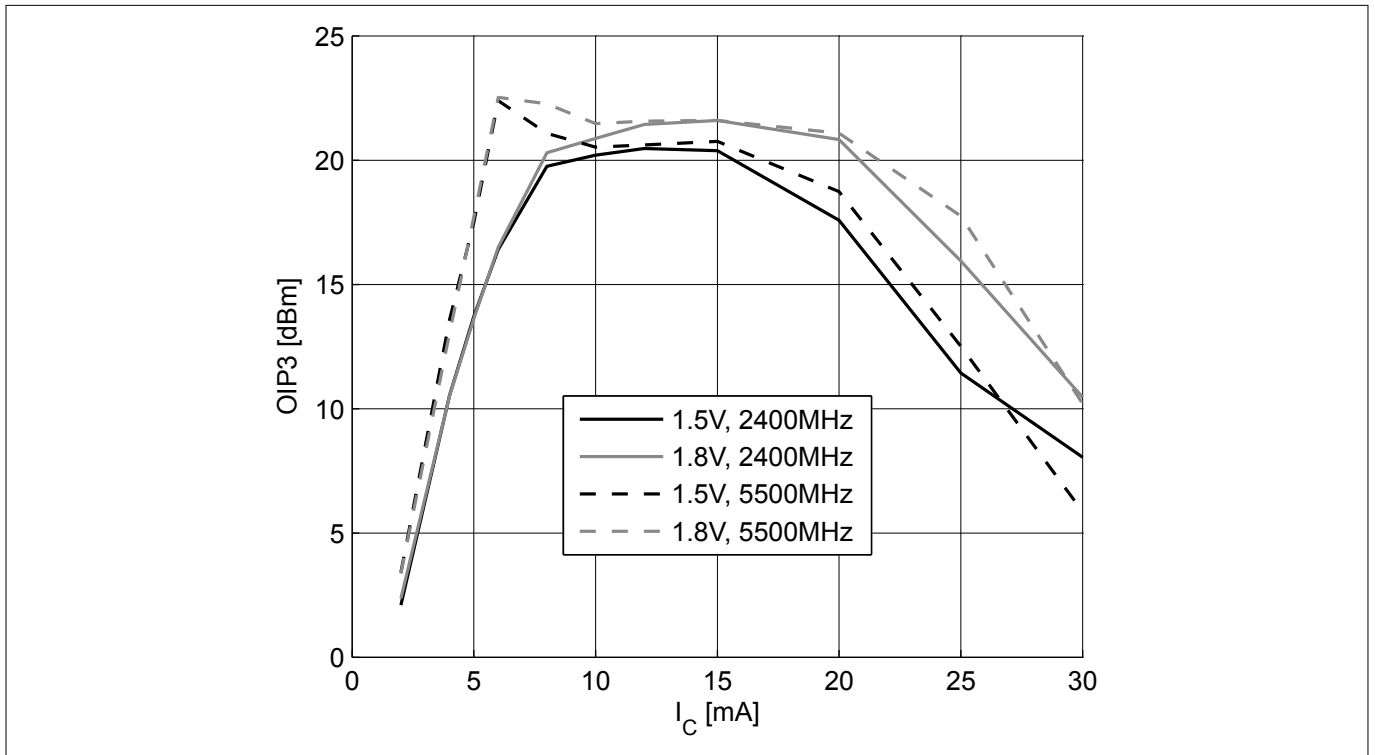

Figure 9 3rd order intercept point at output $OIP_3 = f(I_C)$, $Z_S = Z_L = 50 \Omega$, V_{CE} , $f =$ parameter

Electrical characteristics

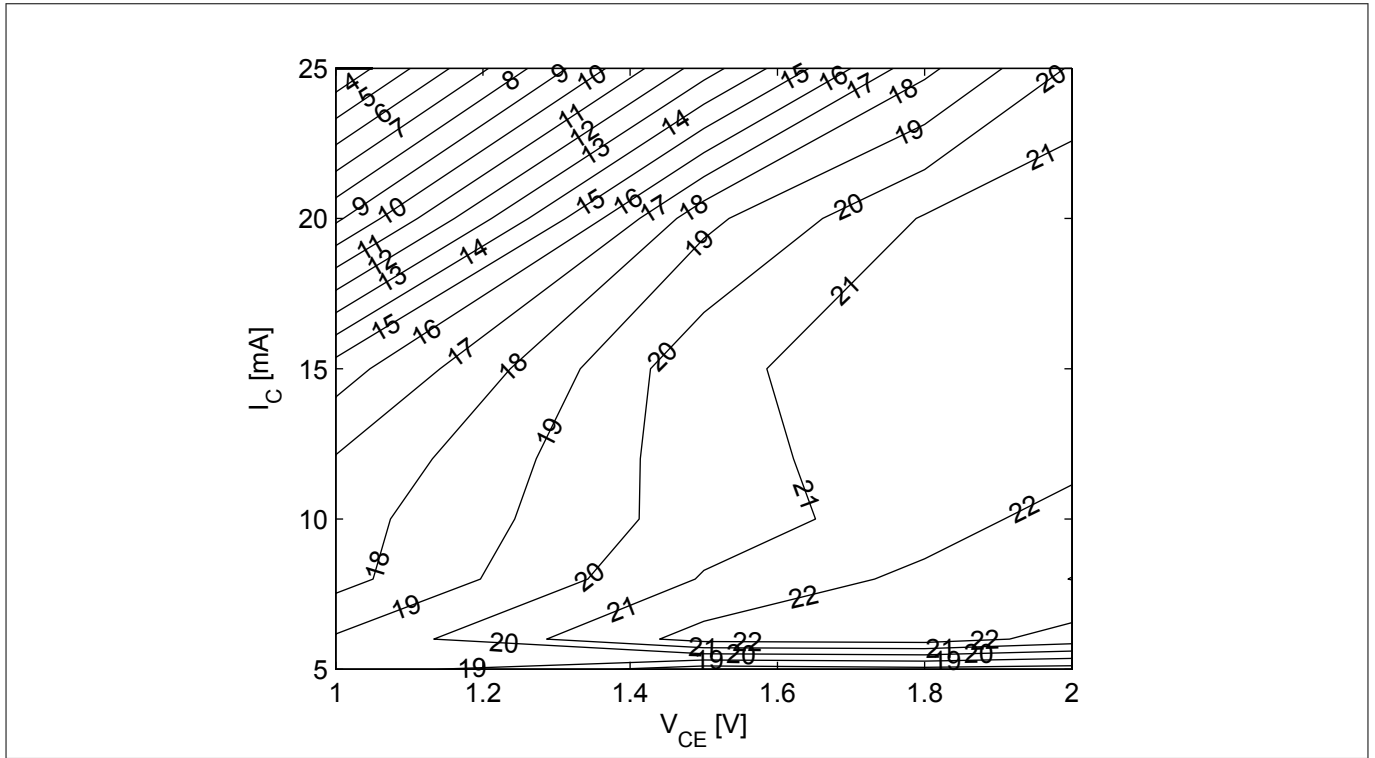

Figure 10 3rd order intercept point at output OIP_3 [dBm] = $f(I_C, V_{CE})$, $Z_S = Z_L = 50 \Omega$, $f = 5.5$ GHz

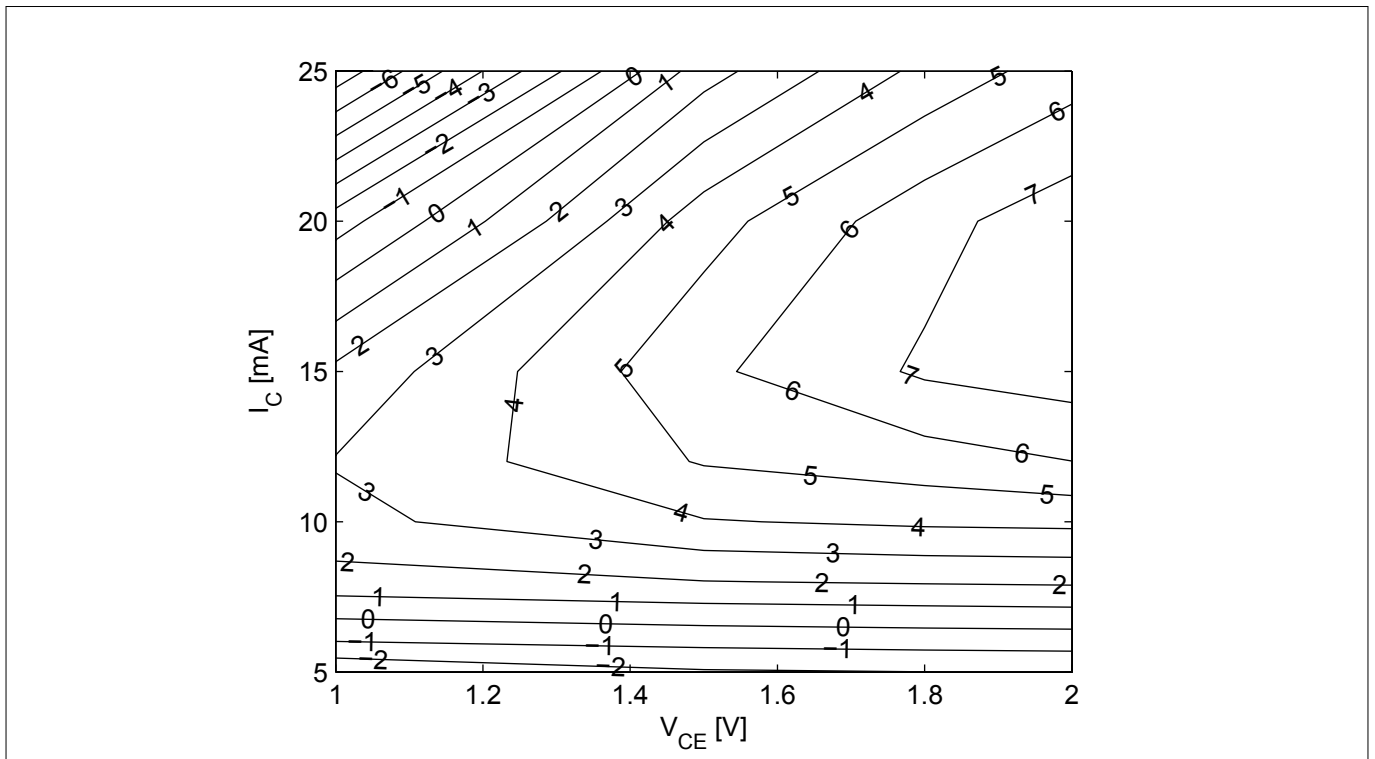

Figure 11 Compression point at output OP_{1dB} [dBm] = $f(I_C, V_{CE})$, $Z_S = Z_L = 50 \Omega$, $f = 5.5$ GHz

Electrical characteristics

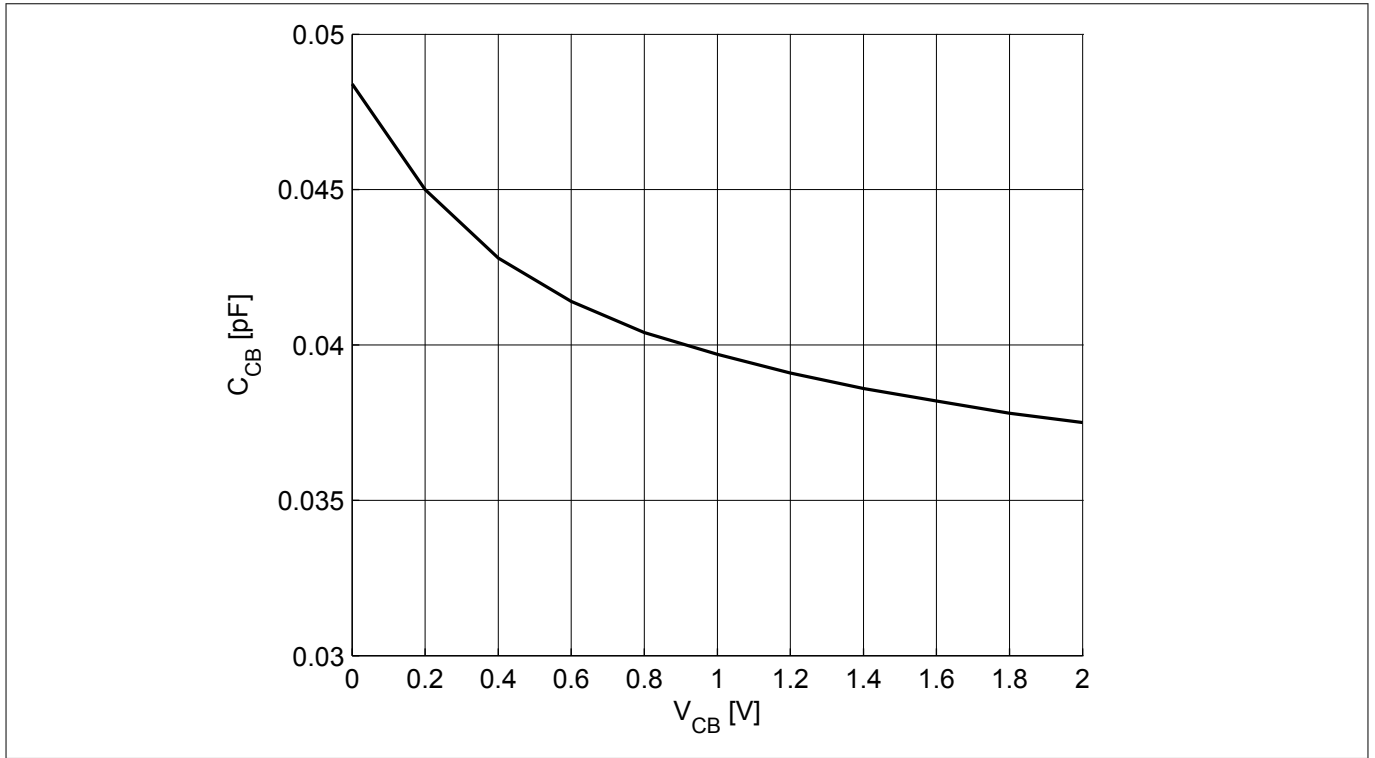

Figure 12 Collector base capacitance $C_{CB} = f(V_{CB})$, $f = 1$ MHz

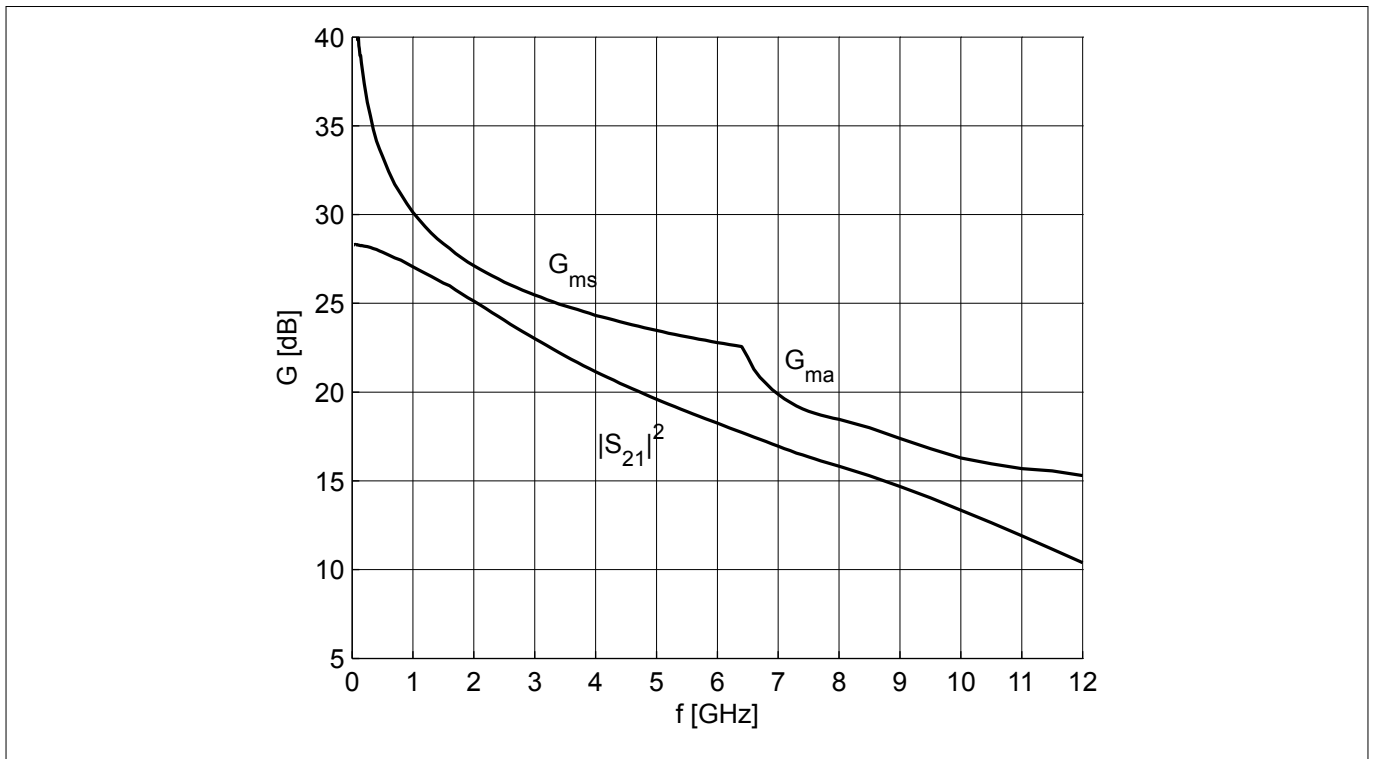

Figure 13 Gain G_{ma} , G_{ms} , $|S_{21}|^2 = f(f)$, $V_{CE} = 1.8$ V, $I_C = 10$ mA

Electrical characteristics

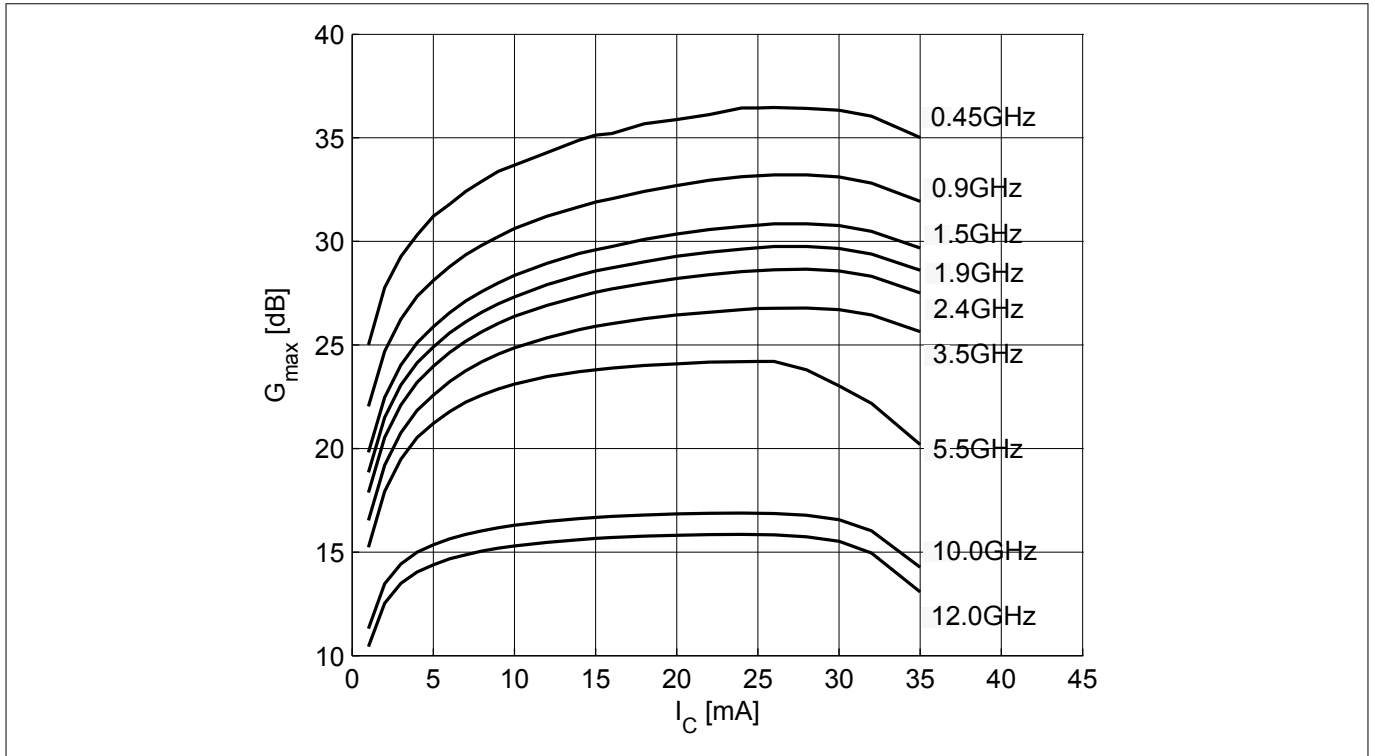

Figure 14 Maximum power gain $G_{max} = f(I_C)$, $V_{CE} = 1.8 V$, $f =$ parameter in GHz

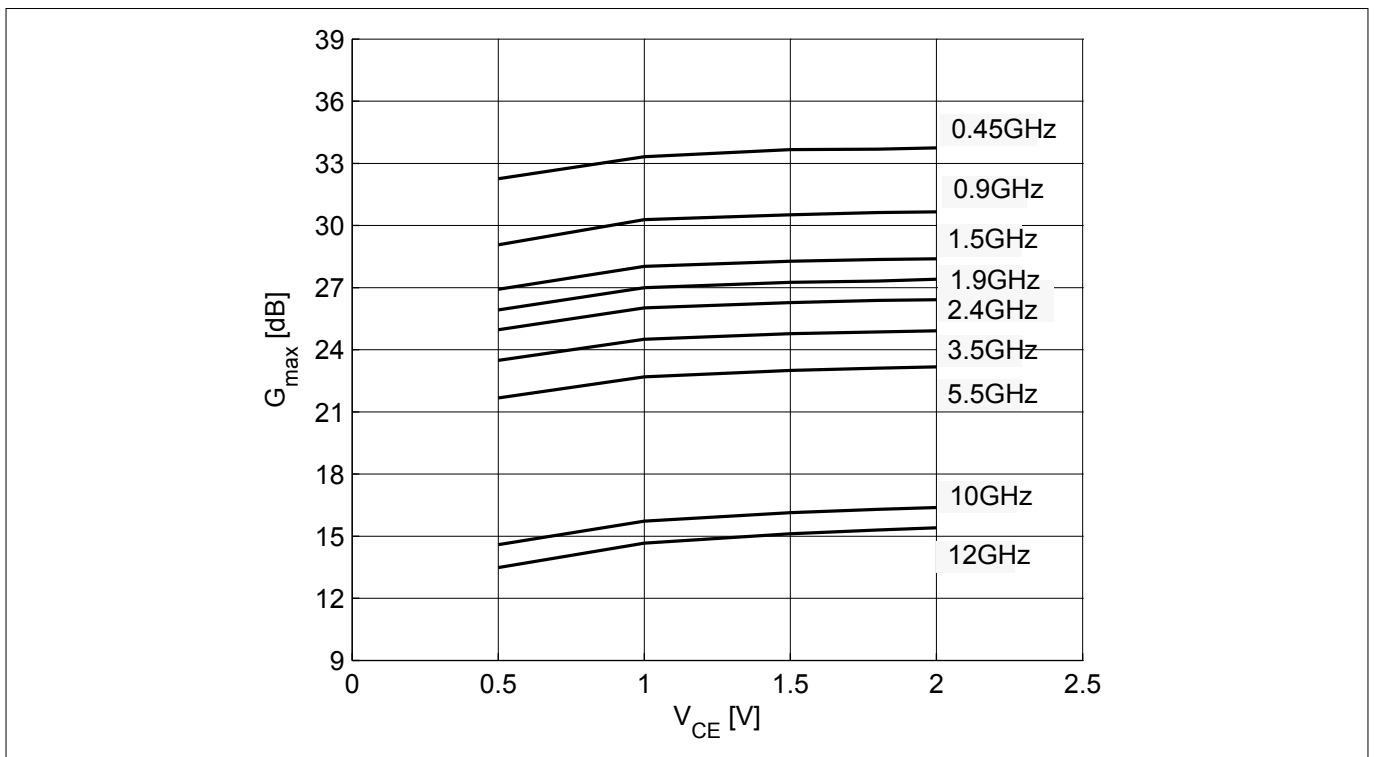

Figure 15 Maximum power gain $G_{max} = f(V_{CE})$, $I_C = 10 mA$, $f =$ parameter in GHz

Electrical characteristics

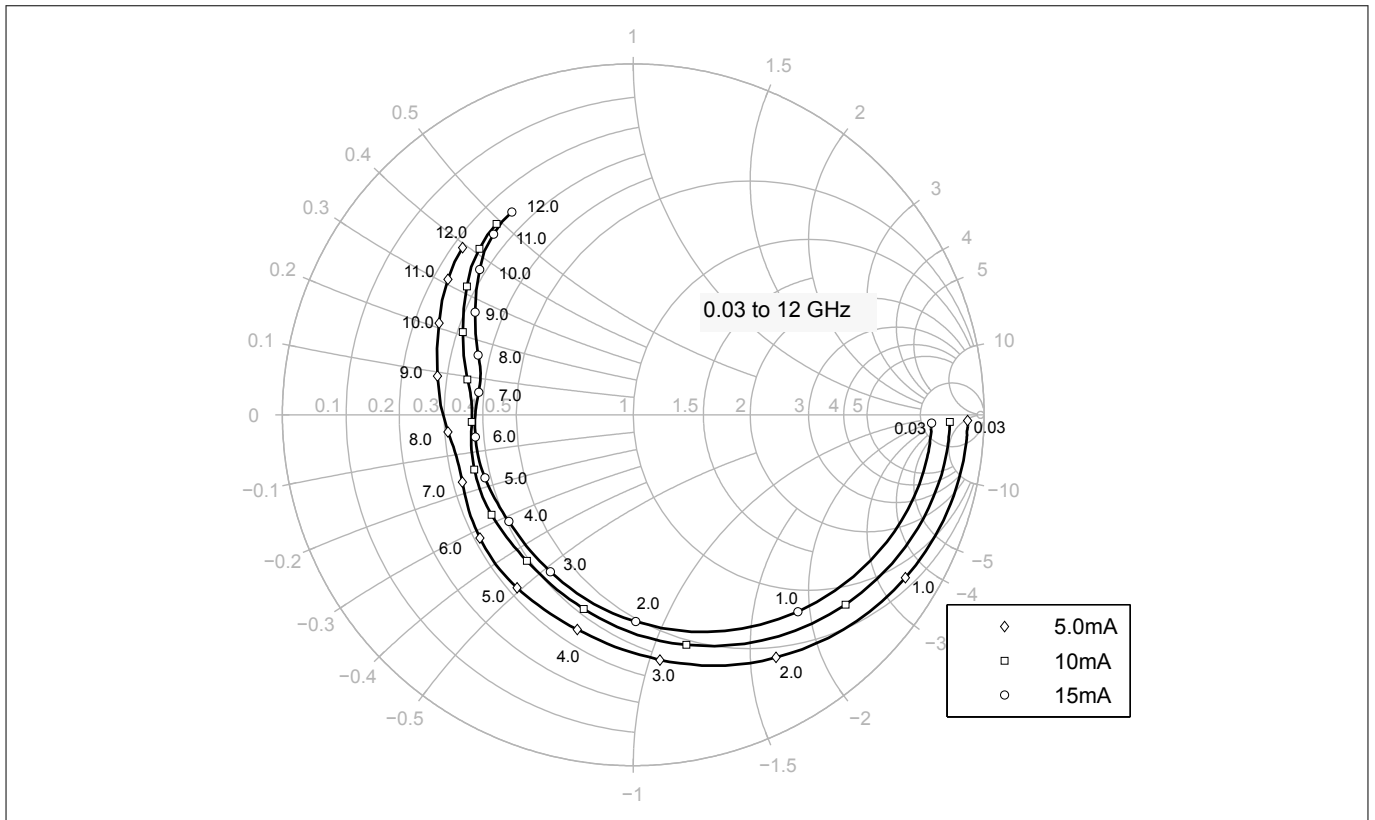

Figure 16 Input reflection coefficient $S_{11} = f(f)$, $V_{CE} = 1.8 \text{ V}$, $I_C = 5 / 10 / 15 \text{ mA}$

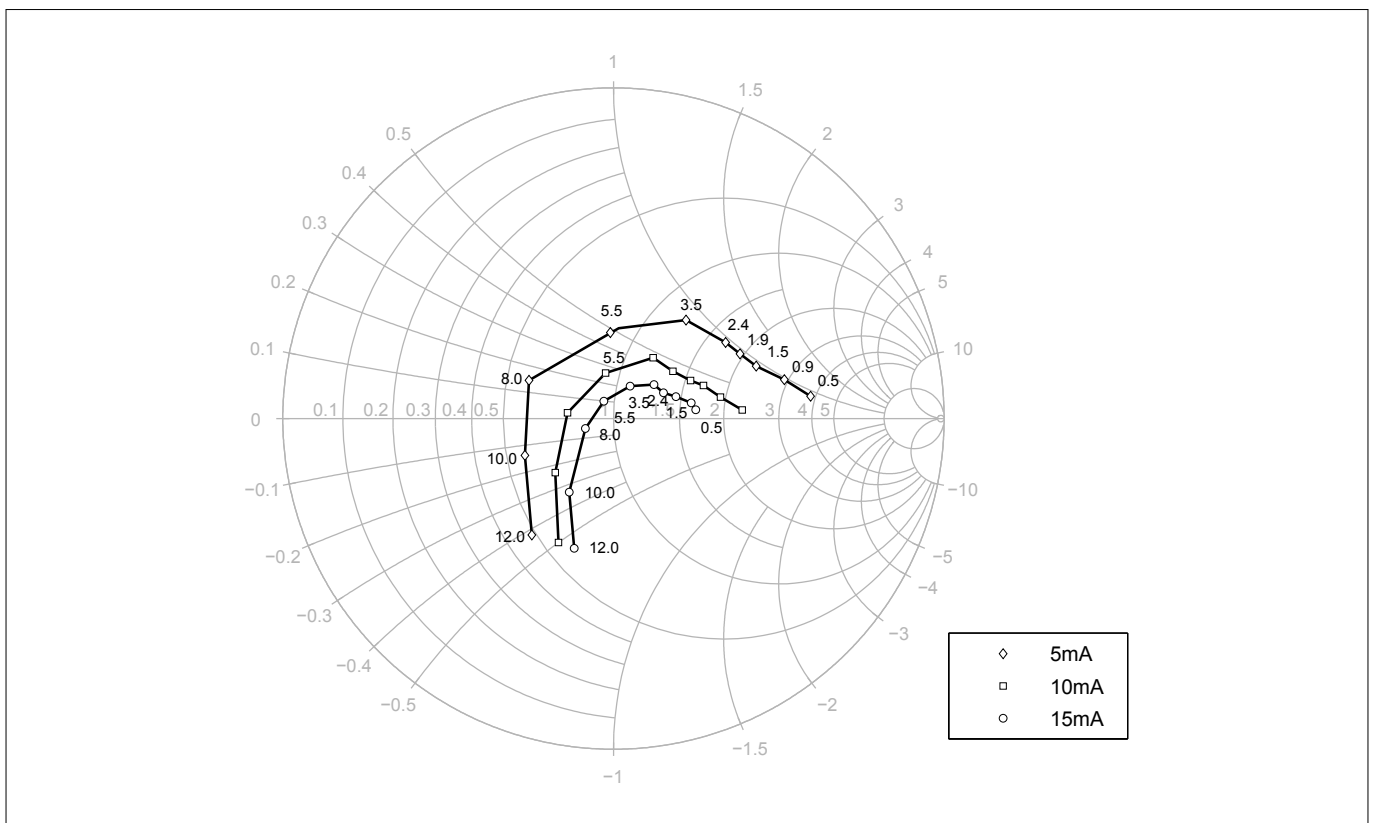

Figure 17 Source impedance for minimum noise figure $Z_{S,opt} = f(f)$, $V_{CE} = 1.8 \text{ V}$, $I_C = 5 / 10 / 15 \text{ mA}$

Electrical characteristics

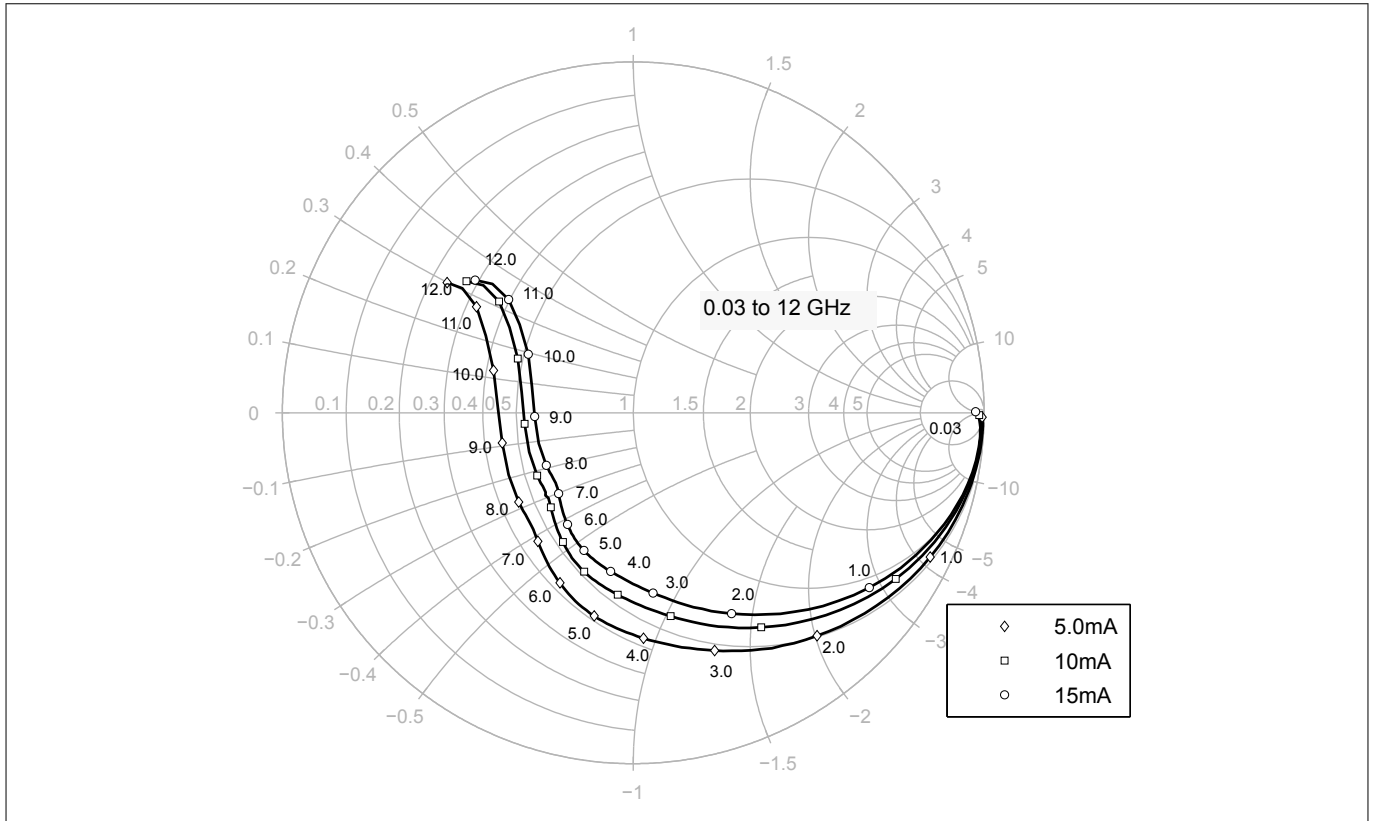

Figure 18 Output reflection coefficient $S_{22} = f(f)$, $V_{CE} = 1.8 \text{ V}$, $I_C = 5 / 10 / 15 \text{ mA}$

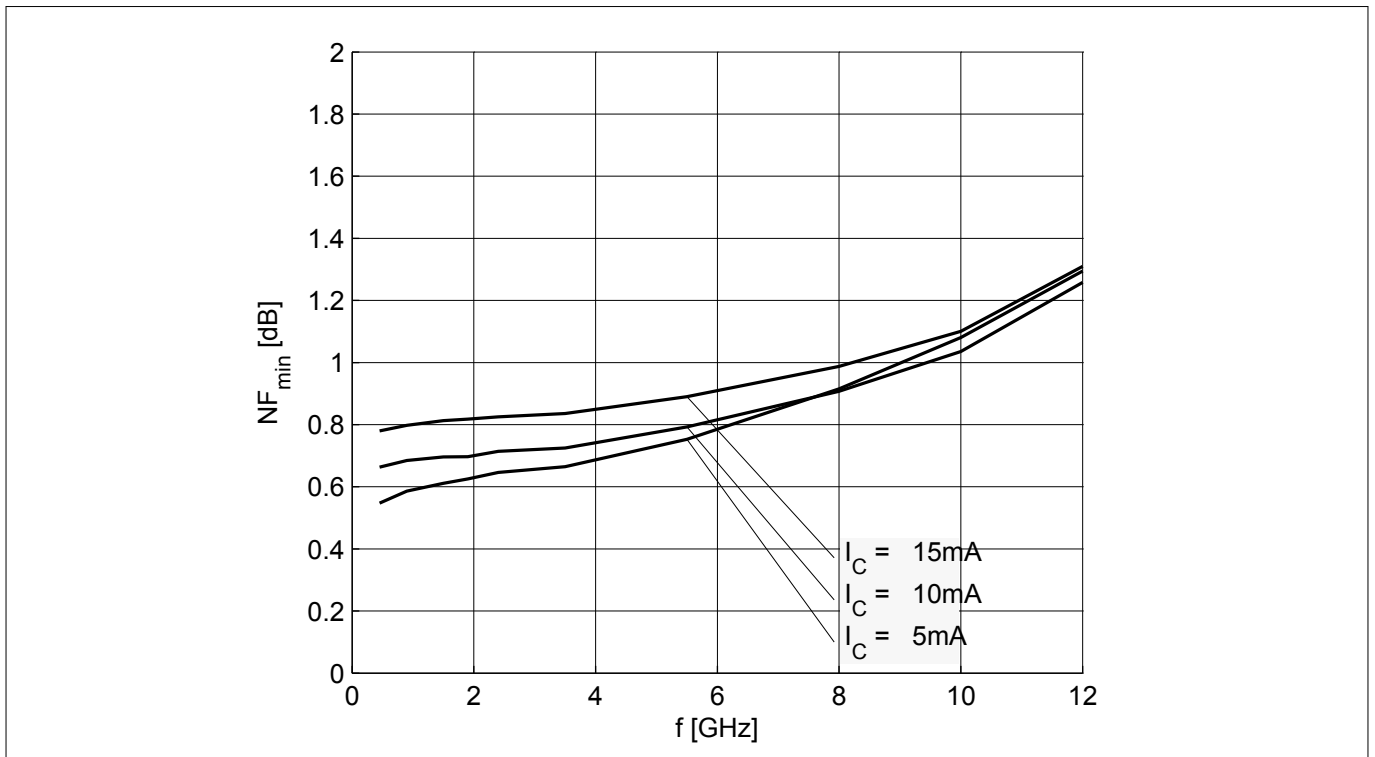

Figure 19 Noise figure $NF_{min} = f(f)$, $V_{CE} = 1.8 \text{ V}$, $Z_S = Z_{S,opt}$, $I_C = 5 / 10 / 15 \text{ mA}$

Electrical characteristics

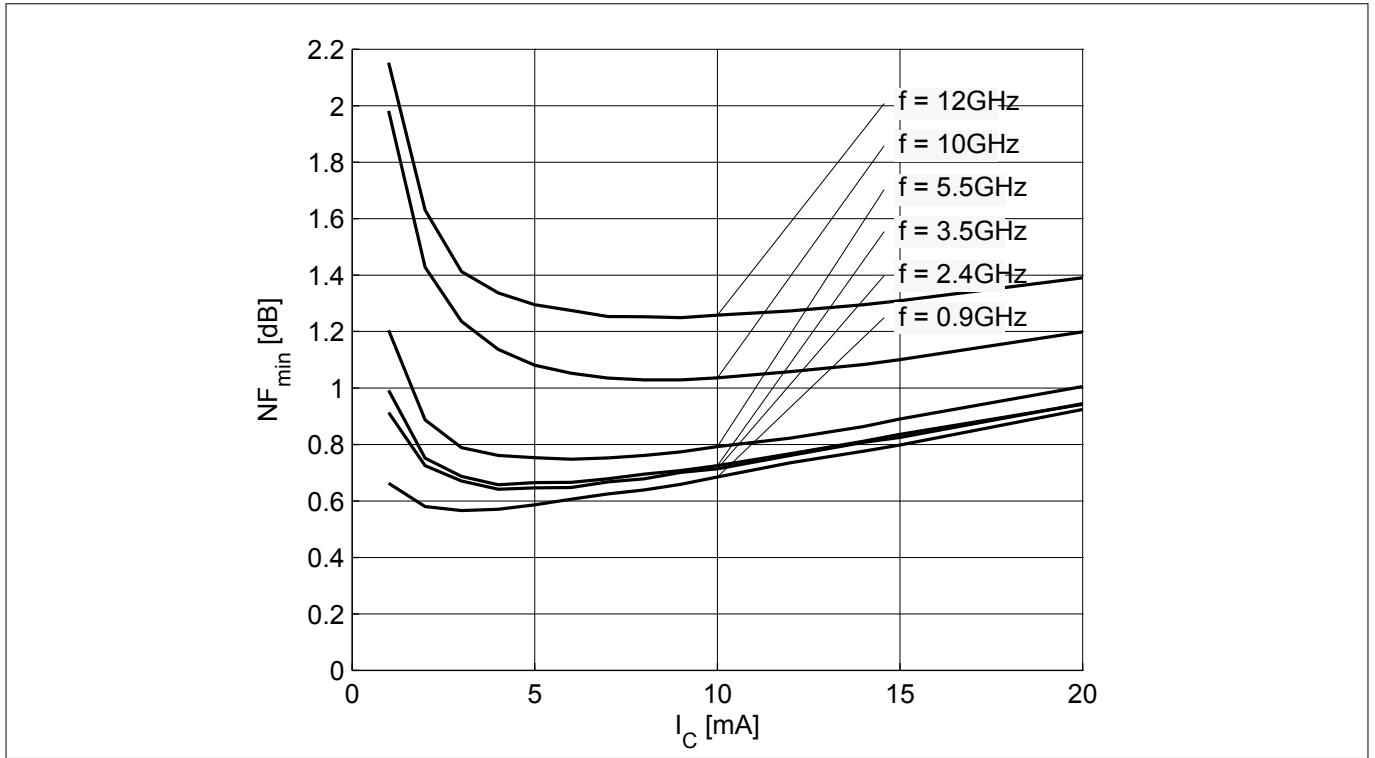

Figure 20 Noise figure $NF_{min} = f(I_C)$, $V_{CE} = 1.8 V$, $Z_S = Z_{S,opt}$, $f =$ parameter in GHz

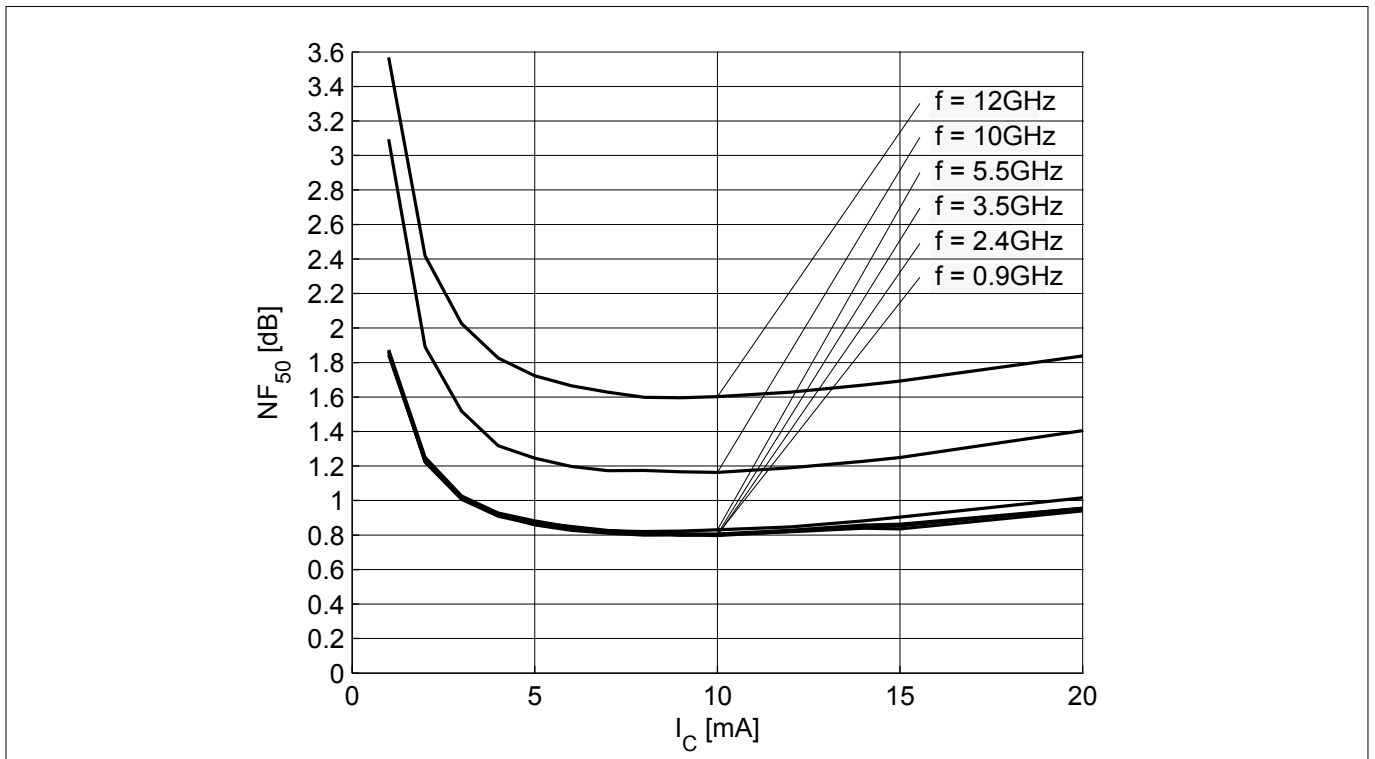

Figure 21 Noise figure $NF_{50} = f(I_C)$, $V_{CE} = 1.8 V$, $Z_S = 50 \Omega$, $f =$ parameter in GHz

Note: The curves shown in this chapter have been generated using typical devices but shall not be considered as a guarantee that all devices have identical characteristic curves. $T_A = 25^\circ C$.

Package information TSFP-4-1

4 Package information TSFP-4-1

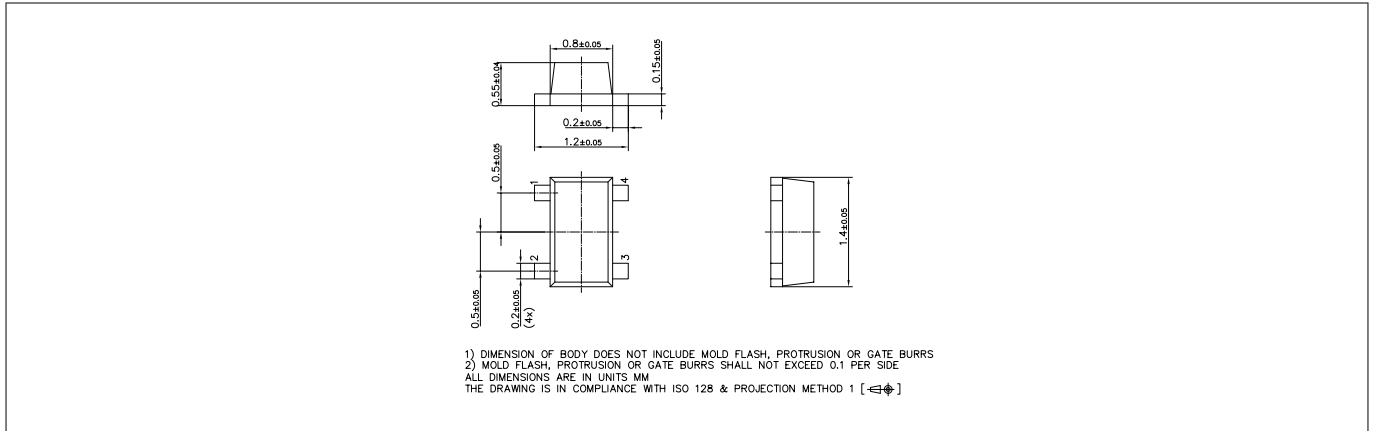

Figure 22 Package outline

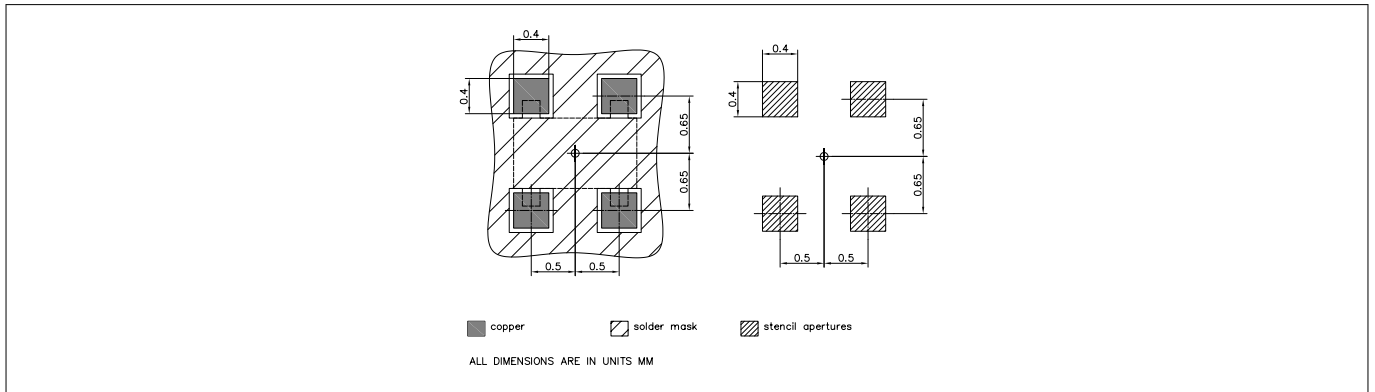

Figure 23 Foot print

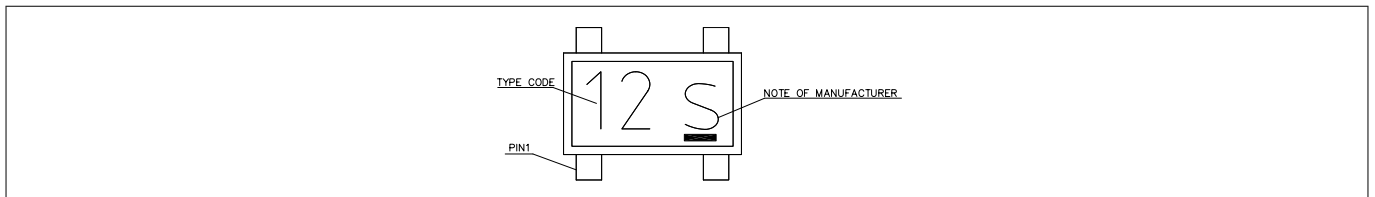

Figure 24 Marking layout example

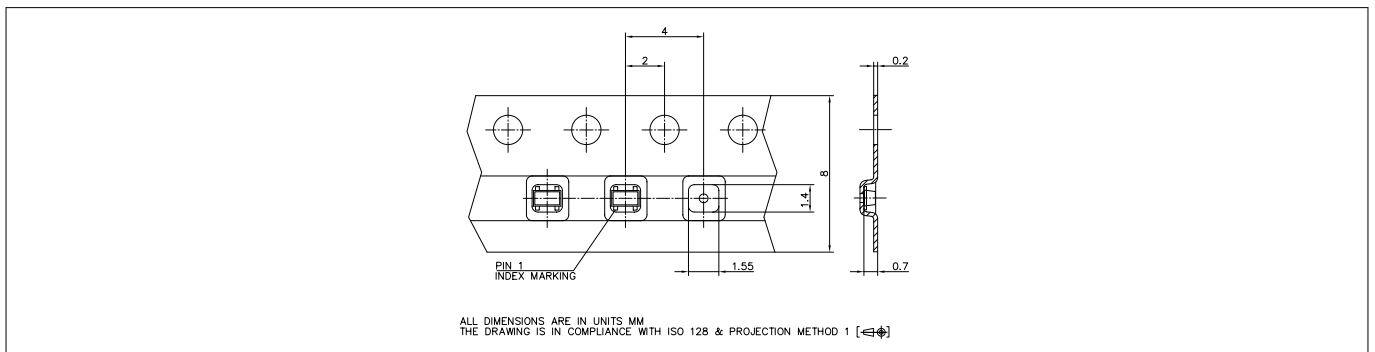

Figure 25 Tape dimensions

Revision history

Revision history

Document version	Date of release	Description of changes
2.0	2018-09-26	New datasheet layout.